

1- Line, Uni-directional, Transient Voltage Suppressor

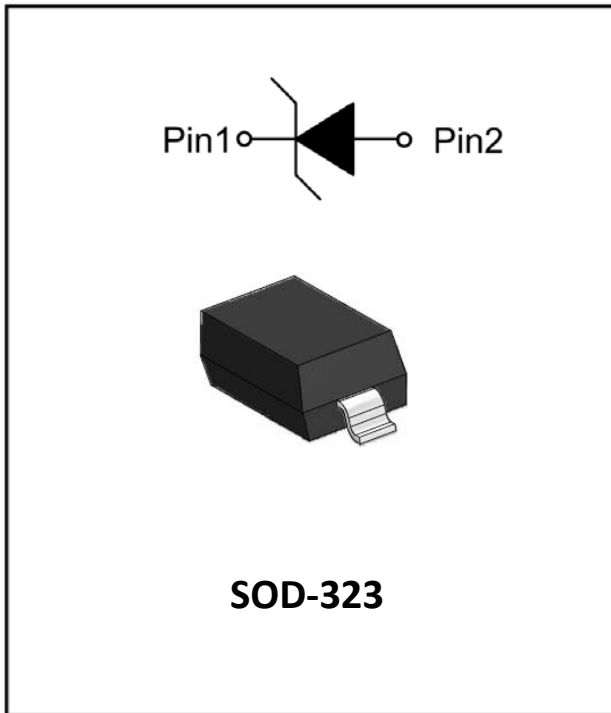

Features

- Stand-off voltage: 30V Max
- Transient protection for each line according to
IEC61000-4-2(ESD): $\pm 8\text{kV}$ (contact)
IEC61000-4-5(surge): 5.5A (8/20 μs)
- Low leakage current:
- Ultra low clamping voltage
- RoHS Compliant

Applications

- Cellular Handsets and Accessories
- Personal Digital Assistants
- Notebooks and Handhelds
- Portable Instrumentation
- Digital Cameras
- Peripherals
- Audio Players

Mechanical Data

- Package: SOD-323
- Lead Finish: Matte Tin
- Case Material: "Green" Molding Compound
- Moisture Sensitivity: Level 1 per J-STD-020
- Marking Information: See Below

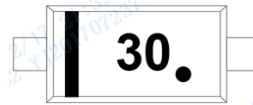

■Definitions of electrical characteristics

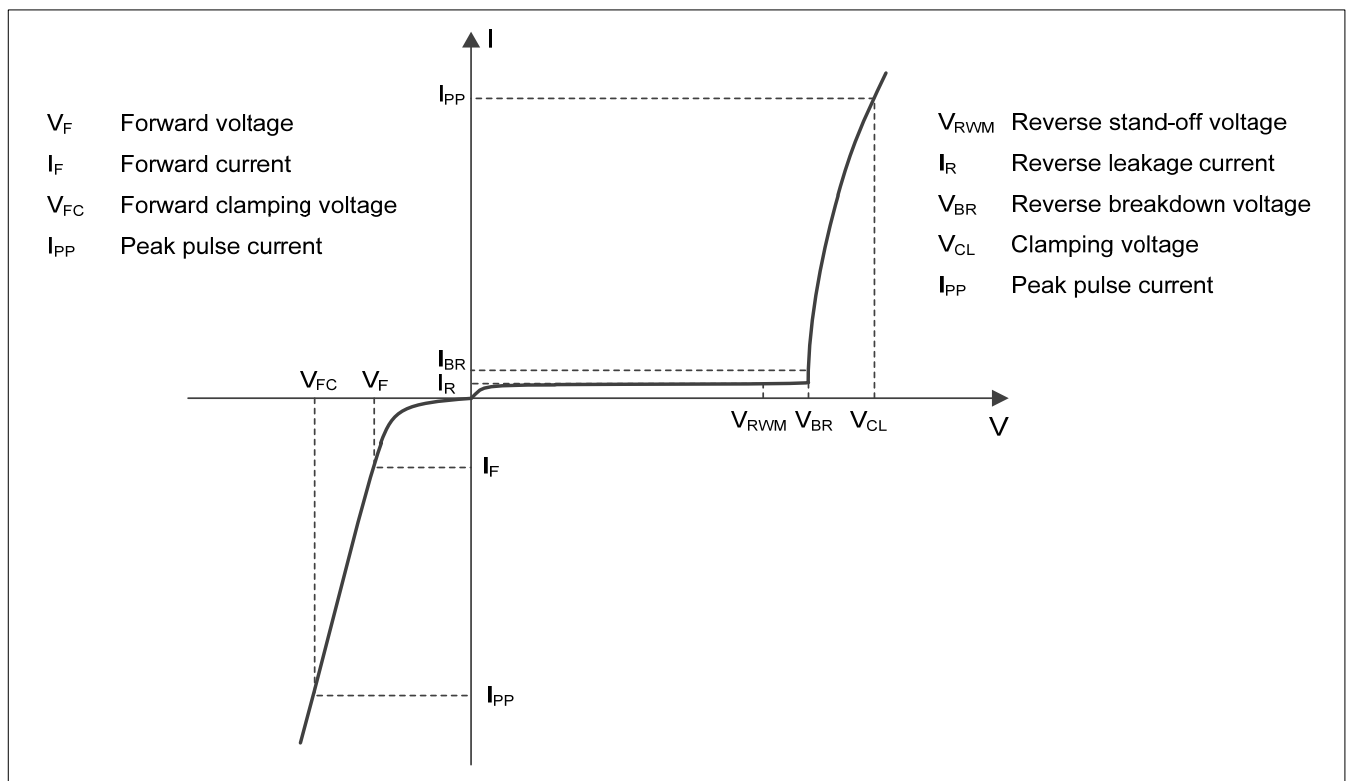



ESD30VD3

■Maximum Ratings

PARAMETER	SYMBOL	LIMITS	UNIT
Peak pulse power ($t_p = 8/20\mu s$)	P_{pk}	357.5	W
Peak pulse current ($t_p = 8/20\mu s$)	I_{PP}	5.5	A
ESD according to IEC61000-4-2 air discharge	V_{ESD}	± 30	KV
ESD according to IEC61000-4-2 contact discharge		± 8	
Junction temperature	T_J	-55~125	$^{\circ}C$
Storage temperature	T_{STG}	-55~150	$^{\circ}C$

■Electrical Characteristics ($T_a=25^{\circ}C$ Unless otherwise specified)

PARAMETER	Symbol	UNIT	Conditions	Min	Typ	Max
Reverse maximum working voltage	V_{RWM}	V				30
Reverse leakage current	I_R	μA	$V_{RWM} = 30V$			0.5
Reverse breakdown voltage	V_{BR}	V	$I_{BR} = 1mA$	32		38
Clamping voltage ²⁾	V_{CL}	V	$I_{PP} = 1A, t_p = 8/20\mu s$			50
		V	$I_{PP} = 5.5A, t_p = 8/20\mu s$			65
Junction capacitance	C_J	pF	$V_R = 0V, f = 1MHz$		19	

Notes:

- (1). TLP parameter: $Z_0 = 50\Omega$, $t_p = 100ns$, $t_r = 2ns$, averaging window from 60ns to 80ns. R_{DYN} is calculated from 4A to 16A.
- (2). Non-repetitive current pulse, according to IEC61000-4-5.

■Ordering Information (Example)

PREFERRED P/N	PACKING CODE	UNIT WEIGHT(mg)	MINIMUM PACKAGE(pcs)	INNER BOX QUANTITY(pcs)	OUTER CARTON QUANTITY(pcs)	DELIVERY MODE
ESD30VD3	F2	Approximate 4	3000	30000	120000	7 reel



■ Characteristics (Typical)

Fig.1 8/20 μ s waveform per IEC61000-4-5

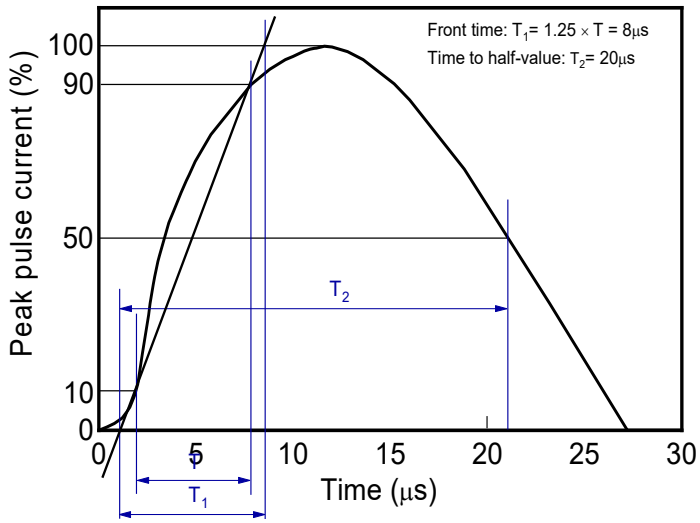

Fig.2 Contact discharge current waveform per IEC61000-4-2

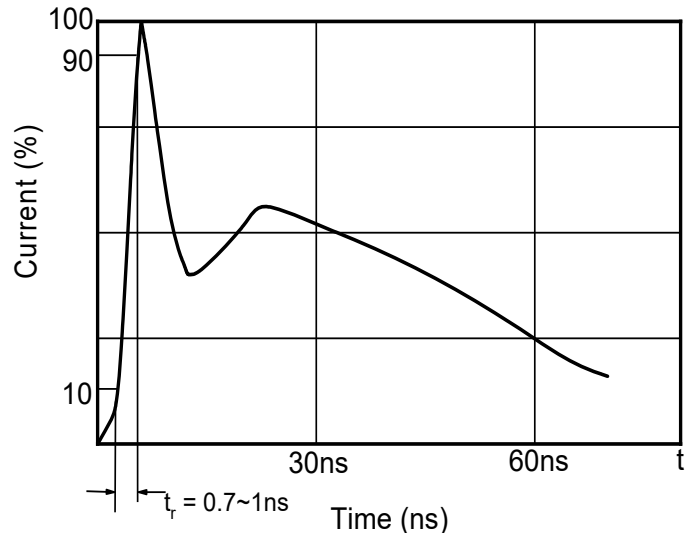

Fig.3 Clamping voltage vs. Peak pulse current

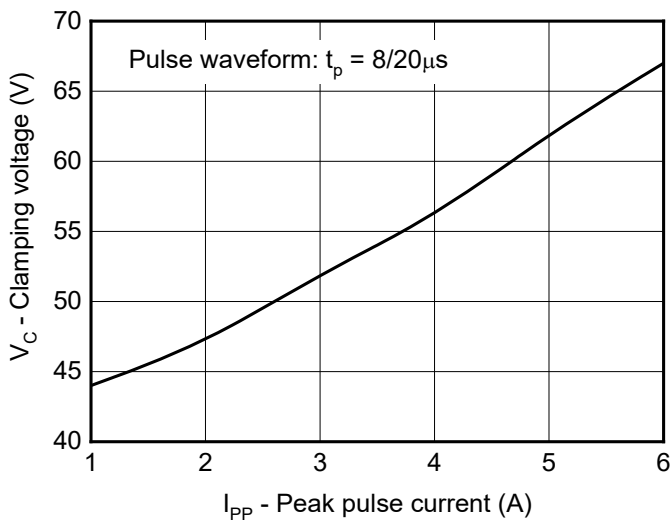

Fig.4 Capacitance vs. Reverse voltage

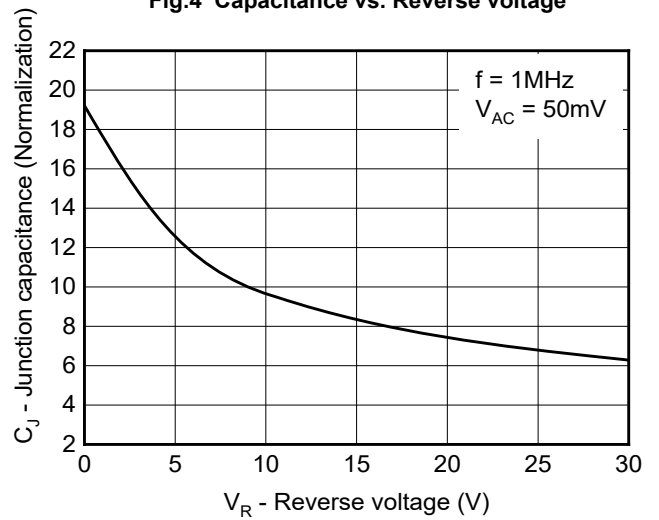

Fig.5 Non-repetitive peak pulse power vs. Pulse time

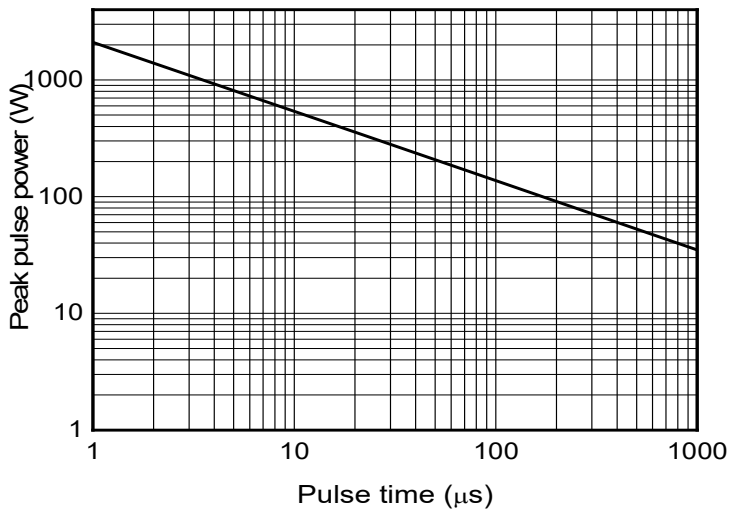
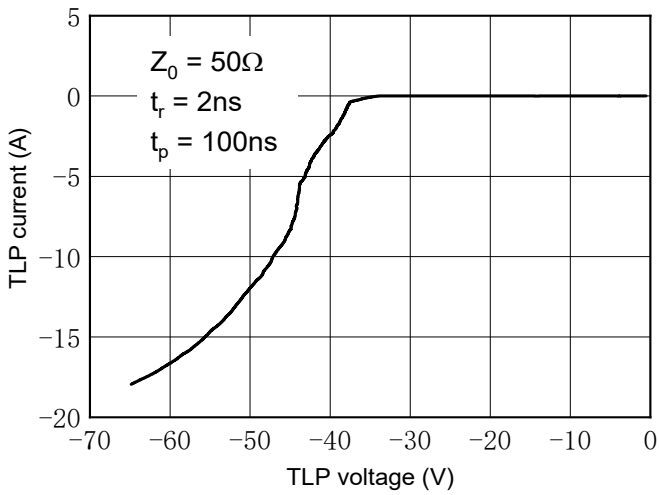

Fig.6 Power derating vs. Ambient temperature



Fig.7 TLP Measurement



Outline Dimensions

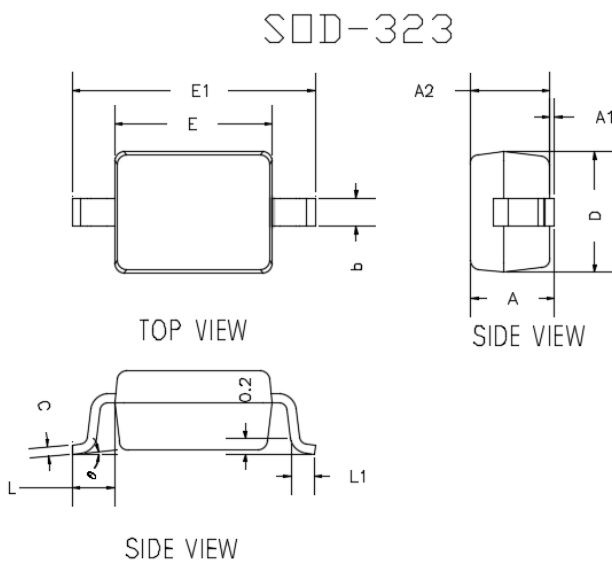

DIMENSIONS				
DIM	INCHES		MM	
	MIN	MAX	MIN	MAX
A	---	0.0393	---	1.0000
A1	0.0000	0.0039	0.0000	0.1000
A2	0.0314	0.0354	0.8000	0.9000
b	0.0098	0.0157	0.2500	0.4000
c	0.0031	0.0059	0.0800	0.1500
D	0.0472	0.0551	1.2000	1.4000
E	0.0629	0.0709	1.6000	1.8000
E1	0.0984	0.1063	2.5000	2.7000
L	0.0187TYP		0.475TYP	
L1	0.0098	0.0157	0.250	0.400
e	0°	8°	0°	8°

Soldering Footprint

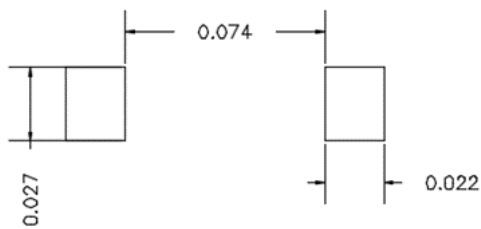

UNIT: inch

SUGGESTED SOLDER PAD LAYOUT



ESD30VD3

Disclaimer

The information presented in this document is for reference only. Yangzhou Yangjie Electronic Technology Co., Ltd. reserves the right to make changes without notice for the specification of the products displayed herein to improve reliability, function or design or otherwise.

The product listed herein is designed to be used with ordinary electronic equipment or devices, and not designed to be used with equipment or devices which require high level of reliability and the malfunction of which would directly endanger human life (such as medical instruments, transportation equipment, aerospace machinery, nuclear-reactor controllers, fuel controllers and other safety devices), Yangjie or anyone on its behalf, assumes no responsibility or liability for any damages resulting from such improper use of sale.

This publication supersedes & replaces all information previously supplied. For additional information, please visit our website [http:// www.21yangjie.com](http://www.21yangjie.com) , or consult your nearest Yangjie's sales office for further assistance.