

## N-Channel Enhancement Mode Field Effect Transistor

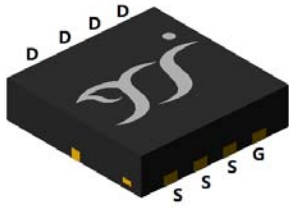

Top View

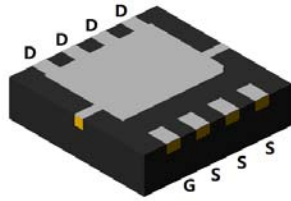

Bottom View

**DFN3333-8L**

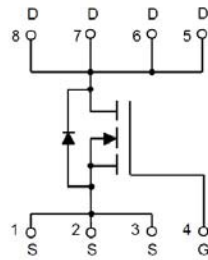

### Product Summary

- $V_{DS}$  40V
- $I_D$  20A
- $R_{DS(ON)}$ ( at  $V_{GS}=10V$ )  $< 15.0m\Omega$
- $R_{DS(ON)}$ ( at  $V_{GS}=4.5V$ )  $< 20.0m\Omega$
- 100% EAS Tested

### General Description

- Excellent package for heat dissipation
- High density cell design for low  $R_{DS(ON)}$
- Part no. with suffix "Q" means AEC-Q101 qualified

### Applications

- Power switching application
- Uninterruptible power supply
- DC-DC convertor
- 12V Automotive systems

### ■ Absolute Maximum Ratings ( $T_A=25^\circ C$ unless otherwise noted)

Parameter	Symbol	Limit	Unit
Drain-source Voltage	$V_{DS}$	40	V
Gate-source Voltage	$V_{GS}$	$\pm 20$	V
Drain Current	$I_D$	$T_C=25^\circ C$	20
		$T_C=100^\circ C$	17
Pulsed Drain Current <sup>A</sup>	$I_{DM}$	80	A
Avalanche energy <sup>B</sup>	EAS	40	mJ
Total Power Dissipation <sup>C</sup>	$P_D$	$T_A=25^\circ C$	2.2
		$T_C=25^\circ C$	21
Thermal Resistance Junction-to-Case	Steady-State	$R_{\theta JC}$	5.9
Thermal Resistance Junction-to-Ambient <sup>D</sup>	Steady-State	$R_{\theta JA}$	55
Junction and Storage Temperature Range	$T_J, T_{STG}$	-55~+150	$^\circ C$

### ■ Ordering Information (Example)

PREFERRED P/N	PACKING CODE	Marking	MINIMUM PACKAGE(pcs)	INNER BOX QUANTITY(pcs)	OUTER CARTON QUANTITY(pcs)	DELIVERY MODE
YJQ20N04AQ	F1	Q20N04	5000	10000	100000	13" reel



# YJQ20N04AQ

## ■ Electrical Characteristics (T<sub>J</sub>=25°C unless otherwise noted)

Parameter	Symbol	Conditions	Min	Typ	Max	Units
<b>Static Parameter</b>						
Drain-Source Breakdown Voltage	BV <sub>DSS</sub>	V <sub>GS</sub> =0V, I <sub>D</sub> =250μA	40	-	-	V
Zero Gate Voltage Drain Current	I <sub>DSS</sub>	V <sub>DS</sub> =40V, V <sub>GS</sub> =0V	-	-	1	μA
Gate-Body Leakage Current	I <sub>GSS</sub>	V <sub>GS</sub> =±20V, V <sub>DS</sub> =0V	-	-	±100	nA
Gate Threshold Voltage	V <sub>GS(th)</sub>	V <sub>DS</sub> =V <sub>GS</sub> , I <sub>D</sub> =250μA	1.0	1.5	2.5	V
Static Drain-Source On-Resistance	R <sub>DS(on)</sub>	V <sub>GS</sub> =10V, I <sub>D</sub> =20A	-	11	15	mΩ
		V <sub>GS</sub> =4.5V, I <sub>D</sub> =10A	-	15	20	
Diode Forward Voltage	V <sub>SD</sub>	I <sub>S</sub> =20A, V <sub>GS</sub> =0V	-	0.85	1.2	V
Gate resistance	R <sub>G</sub>	f=1MHz, Open drain	-	3.5	-	Ω
<b>Dynamic Parameters</b>						
Input Capacitance	C <sub>iss</sub>	V <sub>DS</sub> =25V, V <sub>GS</sub> =0V, f=1MHz	-	1050		pF
Output Capacitance	C <sub>oss</sub>		-	130		
Reverse Transfer Capacitance	C <sub>rss</sub>		-	100		
<b>Switching Parameters</b>						
Total Gate Charge	Q <sub>g</sub>	V <sub>GS</sub> =10V, V <sub>DS</sub> =20V, I <sub>D</sub> =20A	-	23	-	nC
Gate-Source Charge	Q <sub>gs</sub>		-	3.5	-	
Gate-Drain Charge	Q <sub>gd</sub>		-	7	-	
Reverse Recovery Charge	Q <sub>rr</sub>	I <sub>F</sub> =20A, di/dt=300A/us	-	11	-	nC
Reverse Recovery Time	t <sub>rr</sub>		-	13	-	ns
Turn-on Delay Time	t <sub>D(on)</sub>	V <sub>GS</sub> =10V, V <sub>DD</sub> =20V, I <sub>DS</sub> =20A	-	4	-	ns
Turn-on Rise Time	t <sub>r</sub>		-	57.5	-	
Turn-off Delay Time	t <sub>D(off)</sub>		-	20.2	-	
Turn-off fall Time	t <sub>f</sub>		-	2.65	-	

A. Repetitive rating; pulse width limited by max. junction temperature.

B. V<sub>DD</sub>=40V, V<sub>G</sub>=10V, L=1mH, I<sub>AS</sub>=9A.

C. P<sub>d</sub> is based on max. junction temperature, using junction-case thermal resistance.

D. The value of R<sub>θJA</sub> is measured with the device mounted on 1 in<sup>2</sup> FR-4 board with 2oz. Copper, in the still air environment with T<sub>A</sub>=25°C. The maximum allowed junction temperature of 150°C. The value in any given application depends on the user's specific board design..



# YJQ20N04AQ

## Typical Electrical and Thermal Characteristics Diagrams

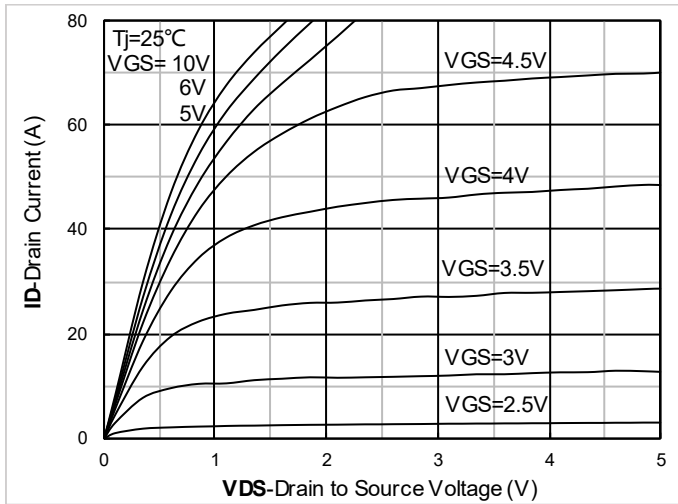

Figure 1. Output Characteristics

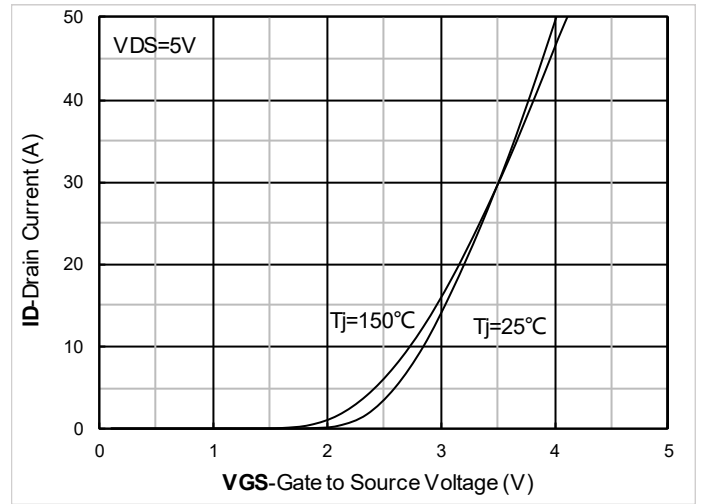

Figure 2. Transfer Characteristics

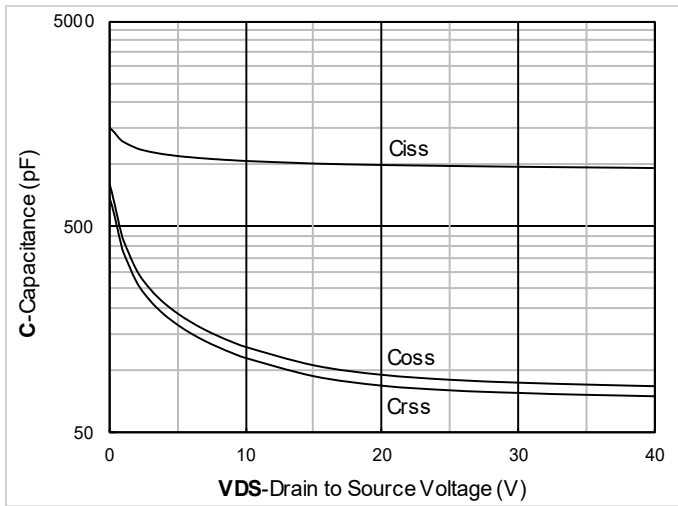

Figure 3. Capacitance Characteristics

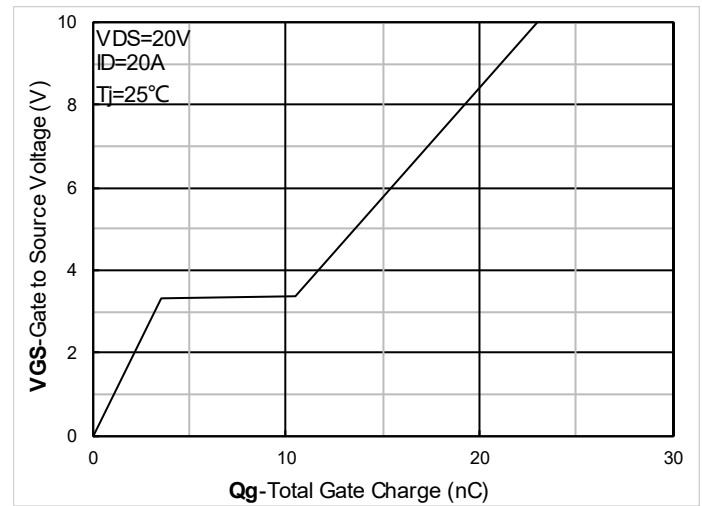

Figure 4. Gate Charge

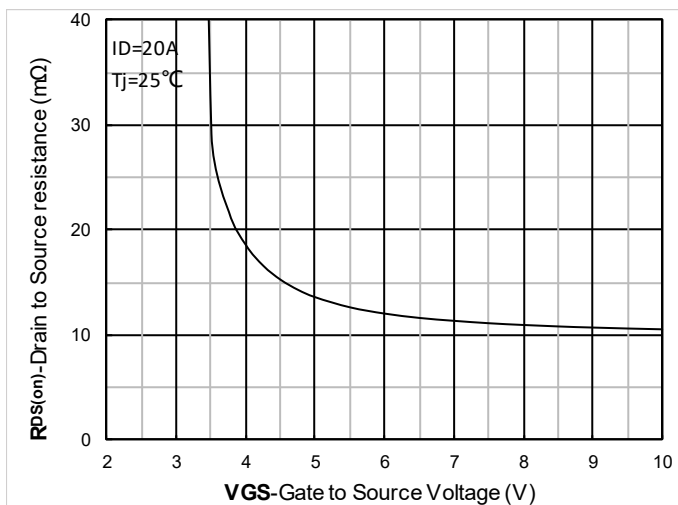

Figure 5. On-Resistance vs Gate to Source Voltage

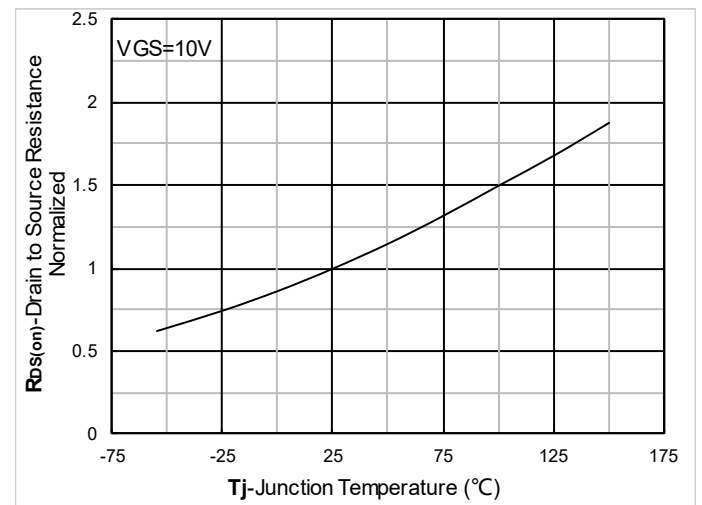

Figure 6. Normalized On-Resistance



# YJQ20N04AQ

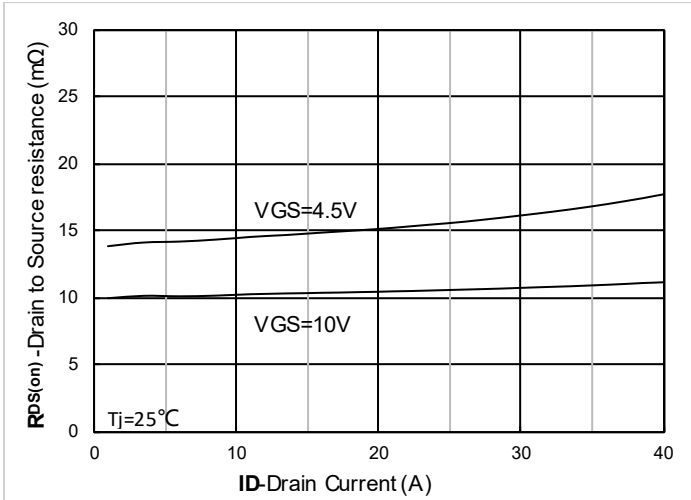

Figure 7.  $R_{DS(on)}$  VS Drain Current

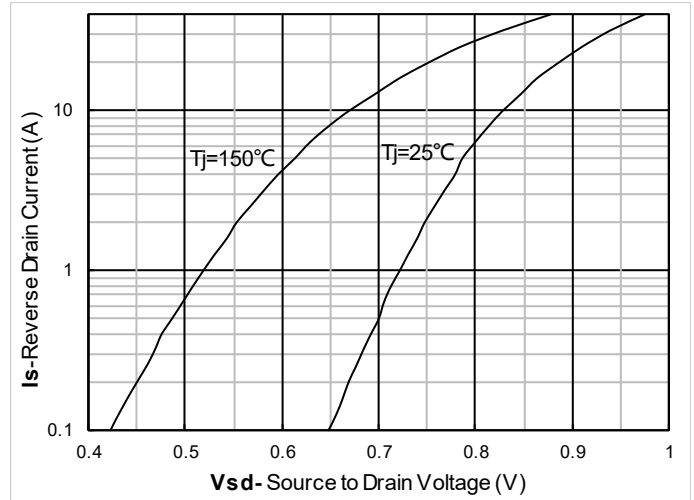

Figure 8. Forward characteristics of reverse diode

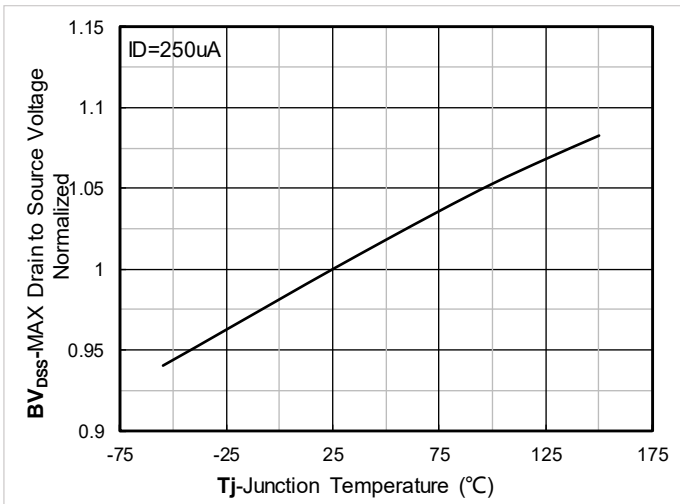

Figure 9. Normalized breakdown voltage

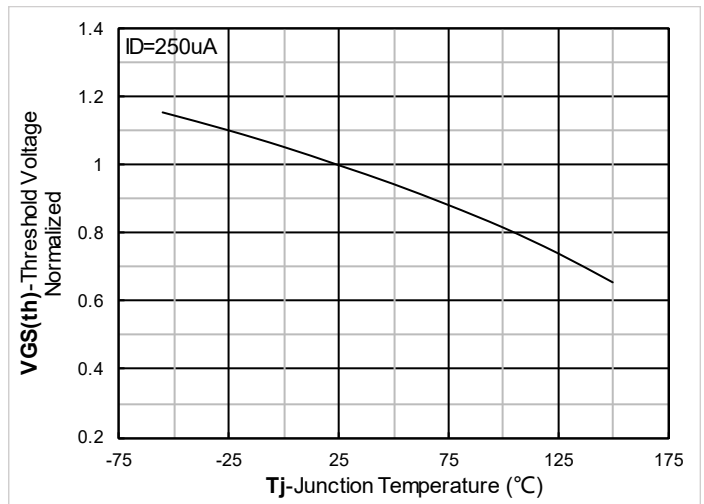

Figure 10. Normalized Threshold voltage

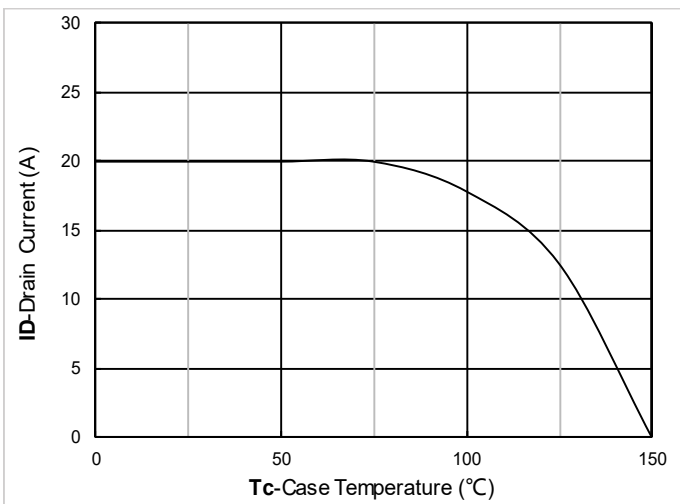

Figure 11. Current dissipation

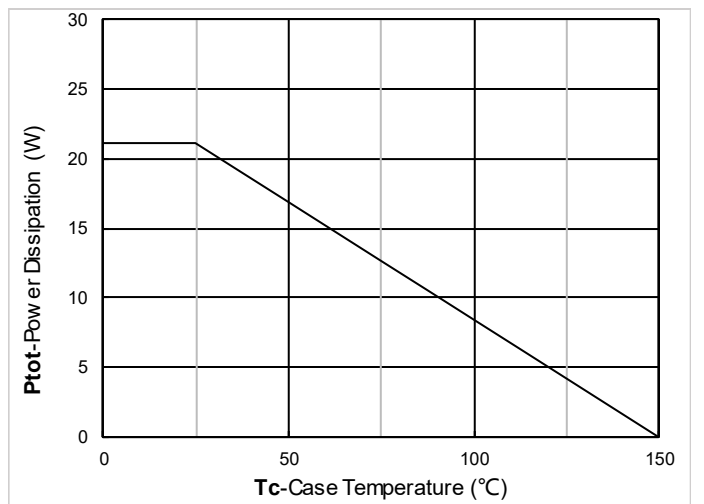

Figure 12. Power dissipation

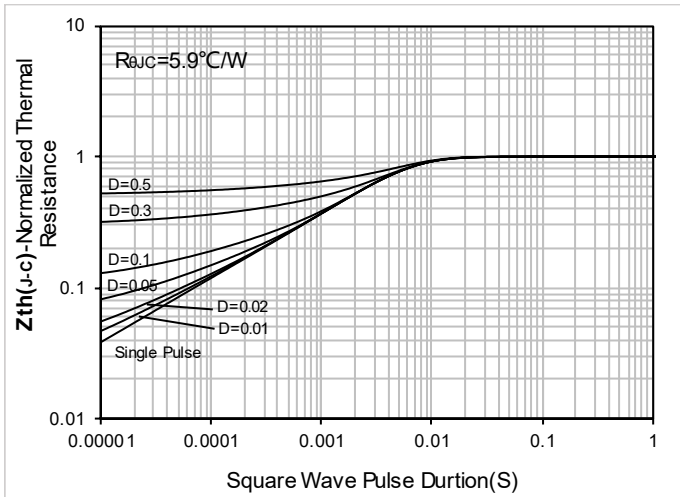

Figure 13. Maximum Transient Thermal Impedance

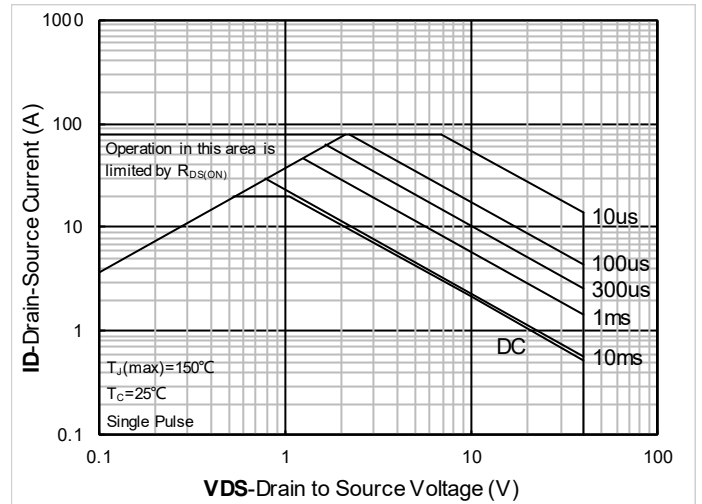
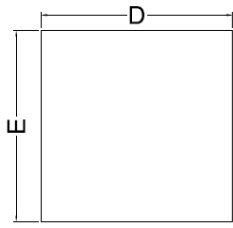

Figure 14. Safe Operation Area



## DFN3333-8L Package information



Top View  
正面视图

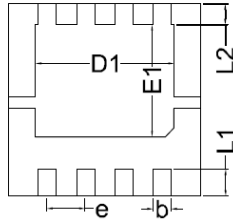

Bottom View  
背面视图

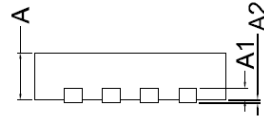

Side View  
侧面视图

SYMBOL	MILLIMETER		
	MIN	NOM	MAX
D	3.15	3.25	3.35
E	3.15	3.25	3.35
A	0.70	0.80	0.90
A1	0.20 BSC		
A2			0.10
D1	2.20	2.35	2.50
E1	1.80	1.90	2.00
L1	0.35	0.45	0.55
L2	0.35 BSC		
b	0.20	0.30	0.40
e	0.65 BSC		

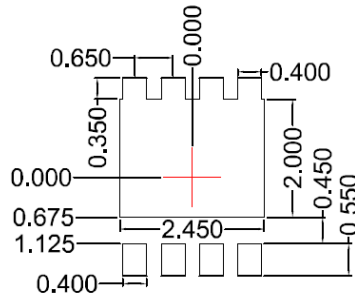

Suggested Solder Pad Layout  
Top View

- Note:
1. Controlling dimension: in millimeters.
  2. General tolerance:  $\pm 0.10\text{mm}$ .
  3. The pad layout is for reference purposes only.



## YJQ20N04AQ

---

### Disclaimer

The information presented in this document is for reference only. Yangzhou Yangjie Electronic Technology Co., Ltd. reserves the right to make changes without notice for the specification of the products displayed herein to improve reliability, function or design or otherwise.

The product listed herein is designed to be used with automotive electronics, are not designed for use in medical, life-saving, lifesustaining, or military, Yangjie or anyone on its behalf, assumes no responsibility or liability for any damages resulting from such improper use of sale.

This publication supersedes & replaces all information previously supplied. For additional information, please visit our website <http://www.21yangjie.com>, or consult your nearest Yangjie's sales office for further assistance.