

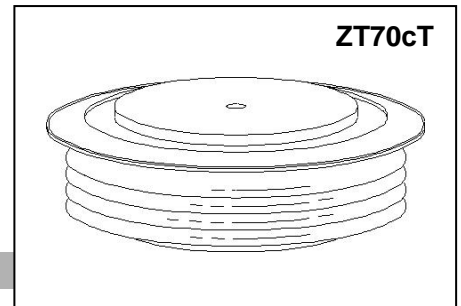

GENERAL PURPOSE HIGH POWER STANDARD RECTIFIER

Features:

- . All Diffused Structure
- . High Surge rating
- . Blocking capability up to 3500 volts
- . Ceramic Housing Hermetic Package
- . Pressure Assembled Device



ELECTRICAL CHARACTERISTICS AND RATINGS

Reverse Blocking

Device Type	V _{RRM} (1)	V _{RSM} (1)
ZP2900-25	2500	2700
ZP2900-26	2600	2800
ZP2900-28	2800	3000
ZP2900-30	3000	3200
ZP2900-32	3200	3400
ZP2900-35	3500	3700

V_{RRM} = Repetitive peak reverse voltage

V_{RSM} = Non repetitive peak reverse voltage (2)

Repetitive peak reverse leakage	I _{RRM}	5 mA 80 mA (3)
---------------------------------	------------------	-------------------

Notes:

All ratings are specified for T_j=25 °C unless otherwise stated.

(1) All voltage ratings are specified for an applied 50Hz/60Hz sinusoidal waveform over the temperature range 0 to +160 °C.

(2) 10 msec. max. pulse width

(3) Maximum value for T_j = 160 °C.

(4) See parameter definition below:

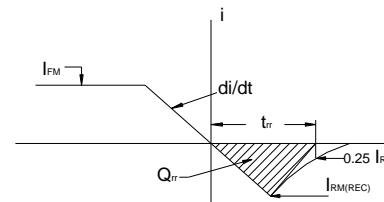

REVERSE RECOVERY CHARACTERIST

Conducting - on state

Parameter	Symbol	Min.	Max.	Typ.	Units	Conditions
Average forward current	I _{F(AV)}		2900		A	Sinewave, 180°, T _c =90°C
RMS forward current	I _{FRMS}		4553		A	Nominal value
Peak one cycle surge (non repetitive) current	I _{FSM}		40600		A	10 msec (50Hz), sinusoidal wave-shape, 180° conduction, T _j = 160 °C
I square t	I ² t		8 × 10 ⁶		A ² s	10 msec
Peak forward voltage	V _{FM}		1.5		V	I _{FM} = 3000A; T _j =25°C
Threshold voltage	V _{FO}		0.82		V	T _j =160°C, I=0.5 π I _{F(AV)} to 1.5 π I _{F(AV)}
Slope resistance	r _F		0.128		mΩ	T _j =160°C, I=0.5 π I _{F(AV)} to 1.5 π I _{F(AV)}
Reverse Recovery Current (4)	I _{RM(REC)}				A	I _{FM} = 500 A; di/dt = -10 A/s; T _{jmax}
Reverse Recovery Charge (4)	Q _{rr}			5500	μC	I _{FM} = 500 A; di/dt = -10 A/s; T _{jmax}
Reverse Recovery Time (4)	t _{rr}				μs	I _{FM} = 500 A; di/dt = -10 A/s; T _{jmax}

Parameter	Symbol	Min.	Max.	Typ.	Units	Conditions
Operating temperature	T_j	-40	+160		°C	
Storage temperature	T_{stg}	-40	+160		°C	
Thermal resistance - junction to case	$R_{\Theta(j-c)}$		0.0125		°C/W	Double sided cooled
Thermal resistance - case to heatsink	$R_{\Theta(c-s)}$		0.004		°C/W	Double sided cooled
Mounting force	P	30	37	33	kN	
Weight	W			0.85	kg.	

* Mounting surfaces smooth, flat and greaseless

CASE OUTLINE AND DIMENSIONS

