

NPN+PNP Digital Transistors (Built-in Resistors)

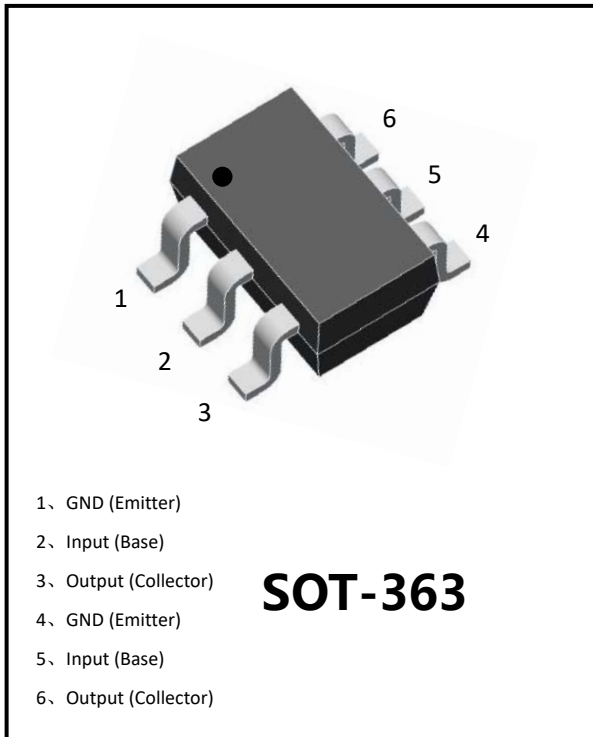

Features

- Epoxy meets UL-94 V-0 flammability rating
- Moisture Sensitivity Level 1
- Built-in bias resistors enable the configuration of an inverter circuit without connecting external input resistors
- Only the on/off conditions need to be set for operation, making the circuit design easy
- Simplifies Circuit Design、Reduces Board Space、Reduces Component Count
- Part no. with suffix "Q" means AEC-Q101 qualified

Application

- Control of IC inputs、Switching loads、Digital system

Mechanical Data

- **Package:** SOT-363
- **Terminals:** Tin plated leads, solderable per J-STD-002 and JESD22-B102
- **Marking:** D3

Equivalent circuit

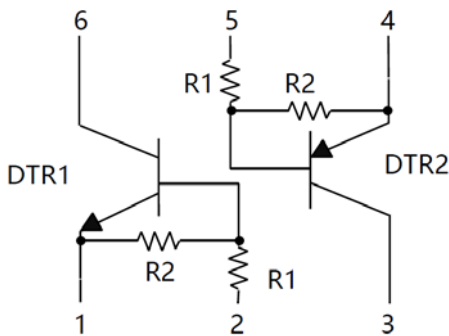



UMD3NQ

■Maximum Ratings (Ta=25°C Unless otherwise specified)

DTR1-NPN

ITEM	SYMBOL	UNIT	VALUE
Collector-Emitter Voltage	V_{CEO}	V	50
Collector-Base Voltage	V_{CBO}	V	50
Emitter-Base Voltage	V_{EBO}	V	10
Supply Voltage	V_{CC}	V	50
Input Voltage	V_{IN}	V	-10 to +40
Collector Current	I_C	mA	100
Power Dissipation (*)	P_D	mW	150
Junction Temperature	T_j	°C	150
Storage Temperature	T_{STG}	°C	-55 to +150

DTR2-PNP

ITEM	SYMBOL	UNIT	VALUE
Collector-Emitter Voltage	V_{CEO}	V	-50
Collector-Base Voltage	V_{CBO}	V	-50
Emitter-Base Voltage	V_{EBO}	V	-10
Supply Voltage	V_{CC}	V	-50
Input Voltage	V_{IN}	V	-40 to +10
Collector Current	I_C	mA	-100
Power Dissipation (*)	P_D	mW	150
Junction Temperature	T_j	°C	150
Storage Temperature	T_{STG}	°C	-55 to +150

(*) Device mounted on FR-4 PCB 1.0 x 1.0 x 0.06 inch



UMD3NQ

■ Electrical Characteristics (Ta=25°C unless otherwise specified)

DTR1-NPN

ITEM	SYMBOL	UNIT	CONDITIONS	MIN	TYP	MAX
Input voltage	$V_{I(off)}$	V	$V_{CC}=5V, I_O=100\mu A$	0.5	-	-
	$V_{I(on)}$	V	$V_O=0.3V, I_O=10mA$	-	-	3
Output voltage	$V_{O(on)}$	V	$I_O=10mA, I_I=0.5mA$	-	-	0.3
Input current	I_I	mA	$V_I=5V$	-	-	0.88
Output current	$I_{O(off)}$	μA	$V_{CC}=50V, V_I=0$	-	-	0.5
DC current gain	G_I		$V_O=5V, I_O=5mA$	30	-	-
Input resistance	R_1	k Ω		7	10	13
Resistance ratio	R_2/R_1			0.8	1	1.2
Transition frequency	f_T	MHz	$V_{CE}=10V, I_E=5mA, f=100MHz$	-	250	-

DTR2-PNP

ITEM	SYMBOL	UNIT	CONDITIONS	MIN	TYP	MAX
Input voltage	$V_{I(off)}$	V	$V_{CC}=-5V, I_O=-100\mu A$	-0.5	-	-
	$V_{I(on)}$	V	$V_O=-0.3V, I_O=-10mA$	-	-	-3
Output voltage	$V_{O(on)}$	V	$I_O=-10mA, I_I=-0.5mA$	-	-	-0.3
Input current	I_I	mA	$V_I=-5V$	-	-	-0.88
Output current	$I_{O(off)}$	μA	$V_{CC}=-50V, V_I=0$	-	-	-0.5
DC current gain	G_I		$V_O=-5V, I_O=-5mA$	30	-	-
Input resistance	R_1	k Ω		7	10	13
Resistance ratio	R_2/R_1			0.8	1	1.2
Transition frequency	f_T	MHz	$V_{CE}=-10V, I_C=-5mA, f=100MHz$	-	250	-

■ Ordering Information (Example)

PREFERRED P/N	PACKING CODE	UNIT WEIGHT(g)	MINIMUM PACKAGE(pcs)	INNER BOX QUANTITY(pcs)	OUTER CARTON QUANTITY(pcs)	DELIVERY MODE
UMD3NQ	F2	Approximate 0.009g	3000	30000	120000	7" reel



■ DTR1 NPN Characteristics (Typical)

Fig.1 - ON Characteristics

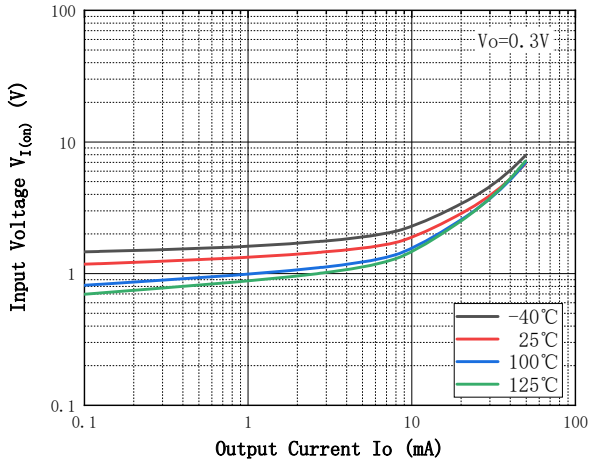

Fig.2 - OFF Characteristics

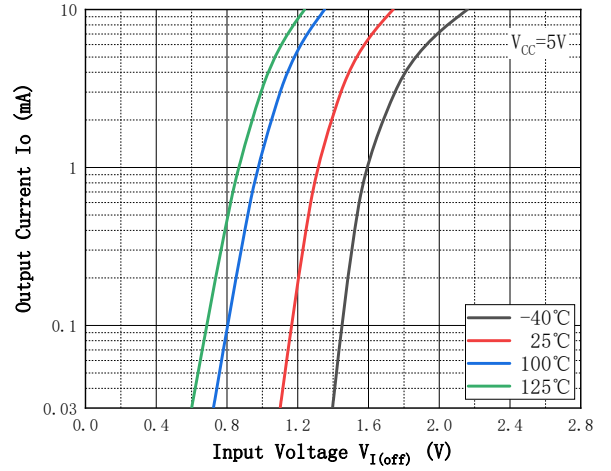

Fig.3 - Output Voltage Characteristics

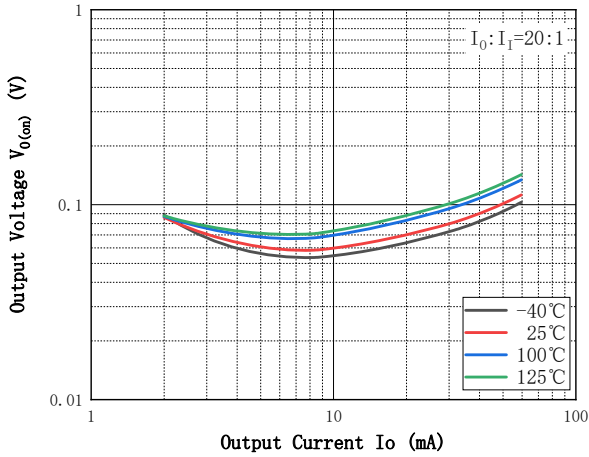

Fig.4 - DC Current Gain Characteristics

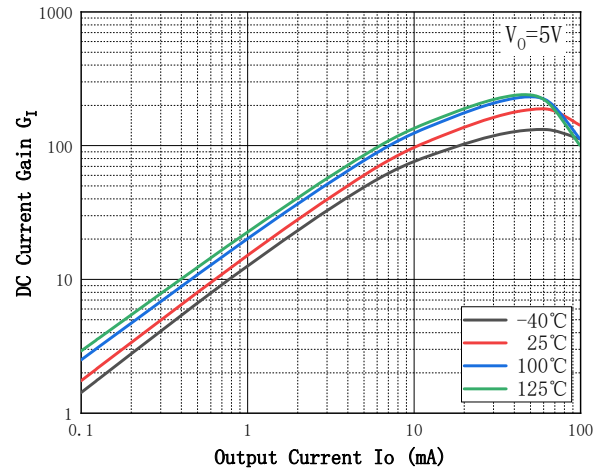
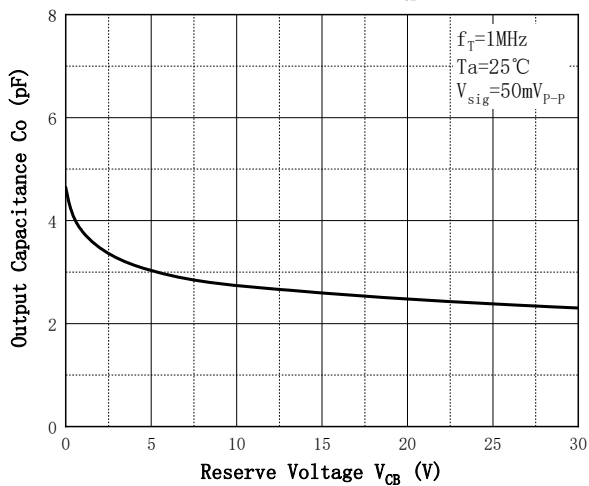

Fig.5 - C_o — V_{CB}





■ DTR2 PNP Characteristics (Typical)

Fig.1 - ON Characteristics

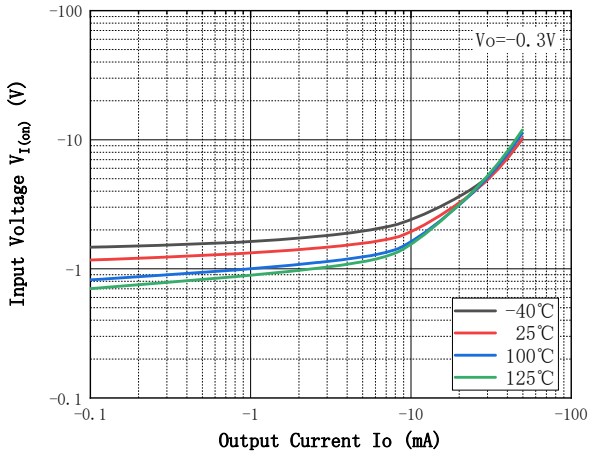

Fig.2 - OFF Characteristics

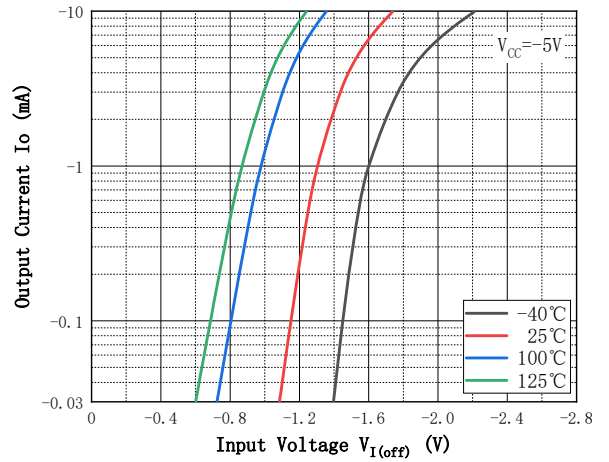

Fig.3 - Output Voltage Characteristics

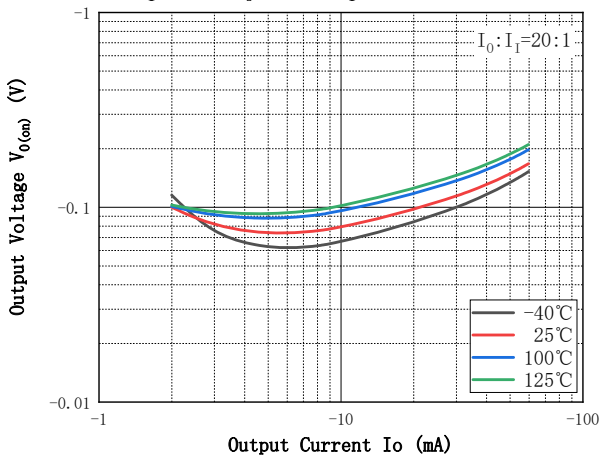

Fig.4 - DC Current Gain Characteristics

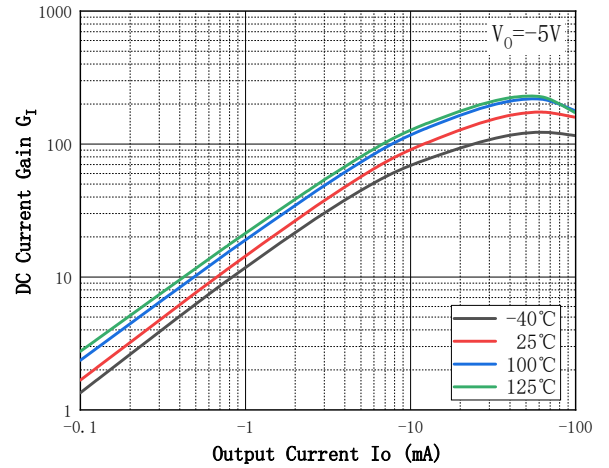
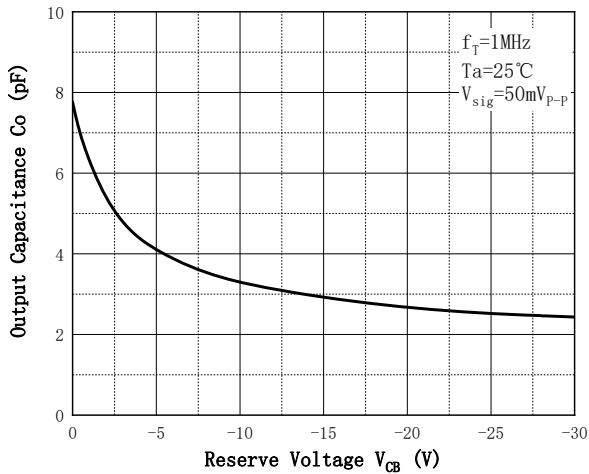

Fig.5 - C_o — V_{CB}





UMD3NQ

■SOT-363 Package Outline Dimensions & Suggested Pad Layout

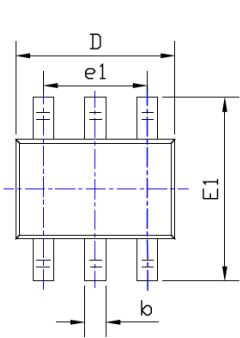

TOP VIEW

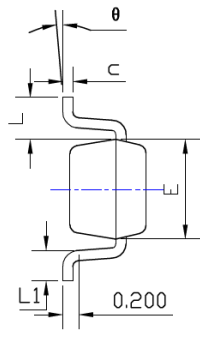

SIDE VIEW

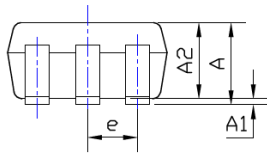

SIDE VIEW

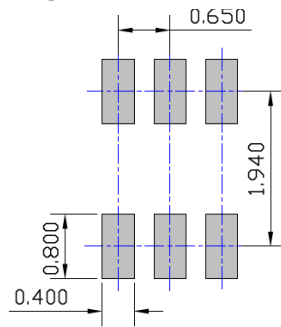

UNIT: mm

SUGGESTED SOLDER PAD LAYOUT

SYMBOL	DIMENSIONS			
	INCHES		Millimeter	
	MIN.	MAX.	MIN.	MAX.
A	0.035	0.043	0.900	1.100
A1	0.000	0.004	0.000	0.100
A2	0.035	0.039	0.900	1.000
b	0.006	0.014	0.150	0.350
c	0.004	0.010	0.100	0.250
D	0.071	0.087	1.800	2.200
E	0.045	0.053	1.150	1.350
E1	0.085	0.096	2.150	2.450
e	0.026TYP		0.650TYP	
e1	0.047	0.055	1.200	1.400
L	0.021REF		0.525REF	
L1	0.010	0.018	0.260	0.460
theta	0°	8°	0°	8°

NOTE:

- 1.PACKAGE BODY SIZES EXCLUDE MOLD FLASH AND GATE BURRS.
- 2.TOLERANCE 0.1mm UNLESS OTHERWISE SPECIFIED.
- 3.THE PAD LAYOUT IS FOR REFERENCE PURPOSES ONLY.



UMD3NQ

Disclaimer

The information presented in this document is for reference only. Yangzhou Yangjie Electronic Technology Co., Ltd. reserves the right to make changes without notice for the specification of the products displayed herein to improve reliability, function or design or otherwise.

The product listed herein is designed to be used with automotive electronics, are not designed for use in medical, life-saving, lifesustaining, or military, Yangjie or anyone on its behalf, assumes no responsibility or liability for any damages resulting from such improper use of sale.

This publication supersedes & replaces all information previously supplied. For additional information, please visit our website [http:// www.21yangjie.com](http://www.21yangjie.com) , or consult your nearest Yangjie's sales office for further assistance.